



MEMS Sensors for health and environmental monitoring

Aarne Oja

20 April 2015

VTT Technical Research Centre of Finland

MEF 2015, Tokyo, 2015

Contents

The purpose of this presentation is to highlight some important enabling technologies which enable new devices & solutions & services for health and environmental monitoring

1. Ultrasonic health, wellness & therapeutic devices
2. Gas sensors for health and environment monitoring
3. Novel imaging devices

pMUT (piezoelectric ultrasonic micromachined transducers) and their applications

Imaging plaster



Proximity sensing



Gesture based user interface

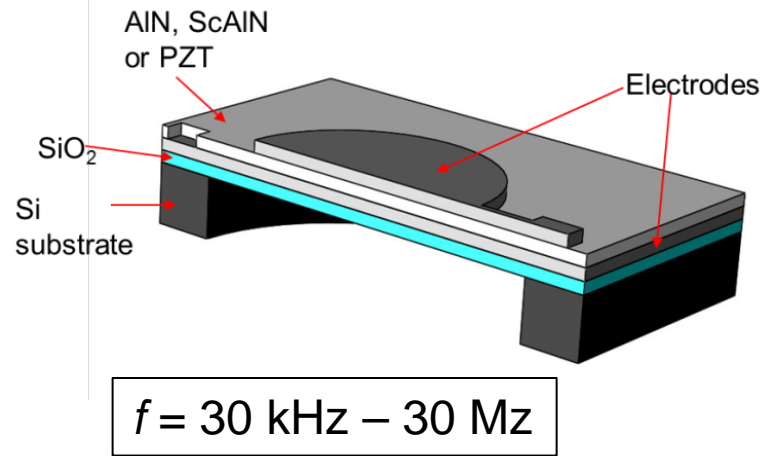

Ultrasonic Near Field Communication



Smart plasters for ultrasonic imaging @ VTT

Value proposition: Wearable imaging device for continuous imaging of body functions and structures

Competitive edge: MEMS ultrasonic transducers offer the same performance as traditional piezoceramic ultrasonic transducers used in professional medical imaging but in a wearable form factor. pMUT superior to cMUT technology in (i) sound power level (ii) no need for high bias voltage

Development phase: Transducers available for application development. Flexible integration platform available

IP status: Manufacturing and design know-how.

Offering: Custom and application specific designs, prototyping, production services, technology transfer.

R&D infrastructure: VTT's Micronova Cleanroom



« BACK

Butterfly Network, a three-year-old tech startup owned by Rothberg, has just announced financing to the tune of \$100 million, and hopes to build its first prototype of a handheld medical imaging device the size of a smartphone in the next 18 months. (22 Dec 2014)

Wide-area sensor arrays on flexible platforms @ VTT

Value proposition: A hybrid process for manufacturing wide-area flexible light sources and flexible sensor arrays.

Competitive edge: Customer-specific lighting system design and pilot manufacturing.

Development phase: Proof of concept for the complete manufacturing process from printed electronics and hybrid integration to in-mould integration.

IP status: Proprietary know-how.

Offering: Feasibility studies, application demonstrators, pilot production.

R&D infrastructure: Design, simulation, prototyping, pilot production and testing facilities.

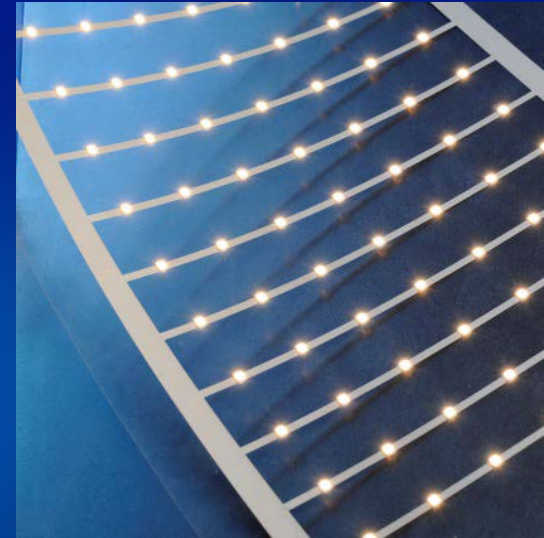

« BACK



Accurate Body Fat %
Track Fat Loss & Muscle Gain
No Embarrassing Pinching

Bodymetrix

www.intelamatrix.com

- Ultrasound 2.5MHz
- More convenient to use than other fat measurements

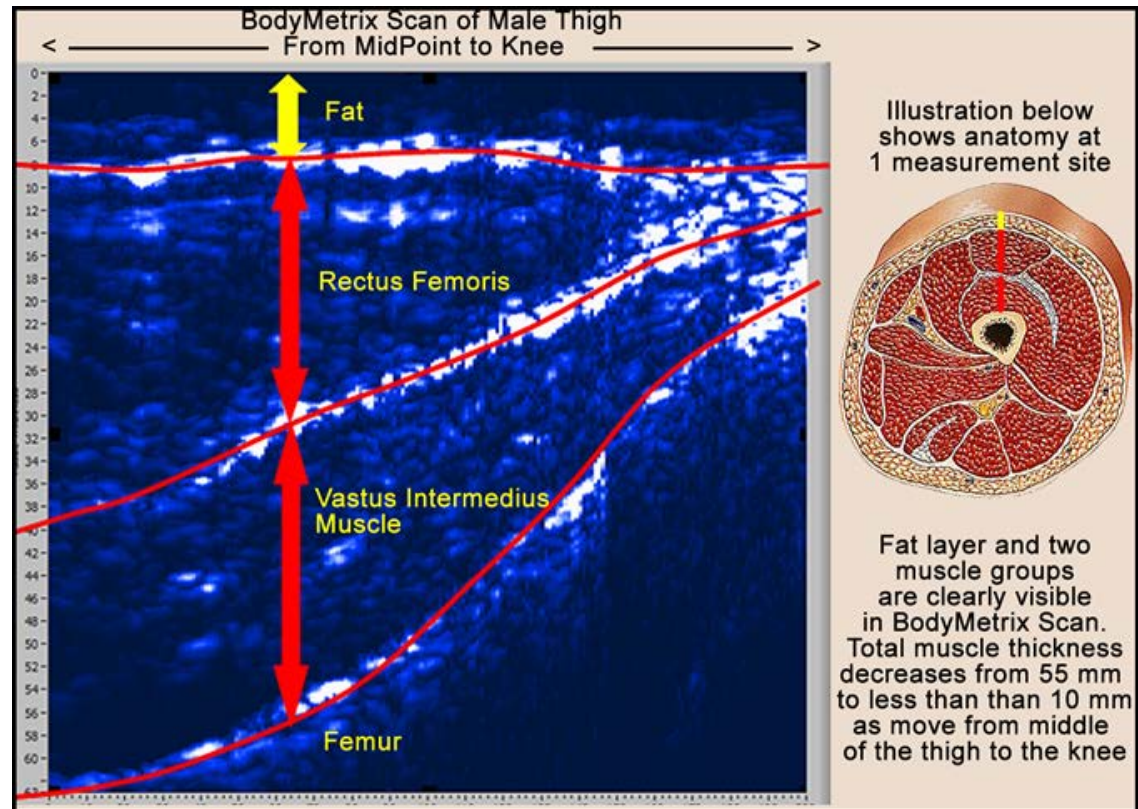
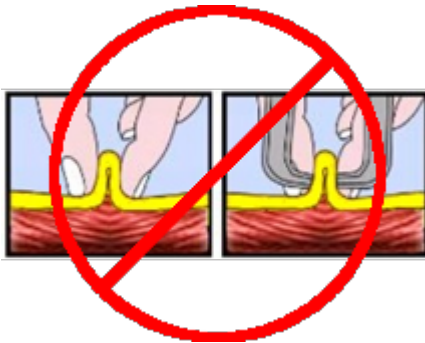

INCITE (Intelligent Catheters in Advanced Systems for Interventions) Project



INCITE technology platform that will enable advanced imaging, sensing (pressure, force, biomarker) and steering functions to be integrated into (sub)millimetre size in-body catheters and surgical instruments for emerging complex minimally invasive cardio-, neuro-, and peripheral vascular interventions.

Ultrasound Could Treat Alzheimer's Disease



<http://www.iflscience.com/health-and-medicine/sound-waves-could-help-treat-alzheimers> (ultrasound helps to pass blood-brain barrier by inducing vibrations of small bubbles injected into the blood stream)

Injecting implantable sensors



MEMS sensors can be made into a needle-like form factor so that they could be injected into the body (electrodes, pressure sensors, ultrasonic transducers, inertial sensors, ..)

Star Trek scalpel-free surgery vs. Today's ultrasound surgery



<http://www.socialphy.com/posts/computers-technology/20540/Star-trek-tech-we-use-today.html>

ChipAir sensor

- On-chip air quality sensor for **ultrafine particles**
- Can be integrated with on-chip CO₂, humidity and pressure sensing
- Small footprint, low-power, integrable to a mobile device
- Personal monitoring and particle dosimetry
- Data can be transmitted to the cloud with the mobile device:
 - pollution maps
 - forecasting

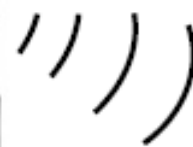
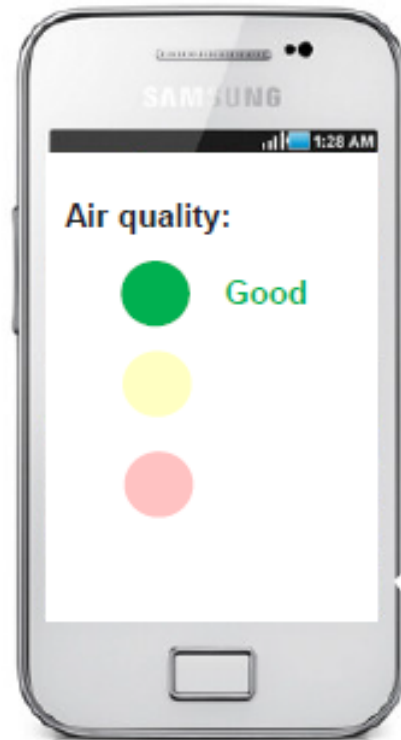

VTT mobile phone CO₂ demo

- CO₂, temperature and humidity sensors integrated in smart phone shield cover
- Measures CO₂ level with 1 second interval
- Averaging time 10 second

- Major use case: monitoring of indoor air quality (f.ex. in meeting rooms)
- Legislation for air quality measurements in German schools



Wellness monitoring from breath



- Gases emerging from metabolism are useful diagnostic indicators
- Early sign of type-II diabetes: acetone at ppm levels
- Ketosis: when acetone above 1.8 ppm (fasting)

MEMS-based breath sensors

- Acetone & aldehyde sensor
 - resolution in the ppm range
- Low-cost MEMS technology available for commercialization

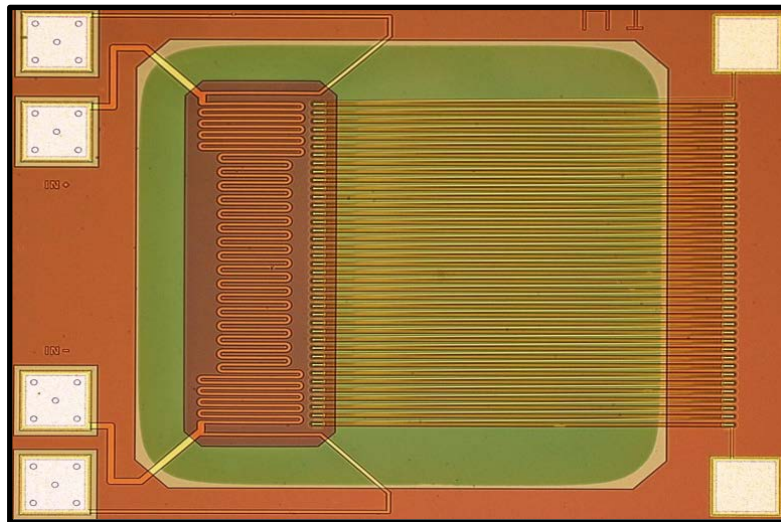

VTT MEMS micropellistor

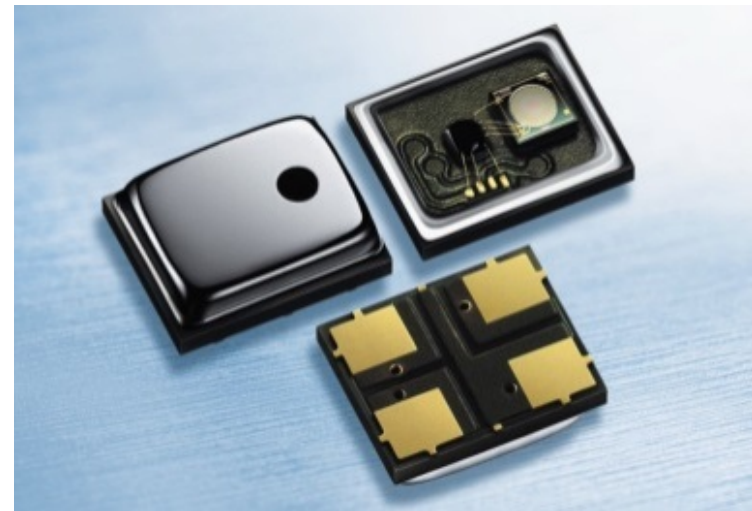

Packaging similar to that of the microphone of Infineon

Enabling MEMS technology for high resolution microspectrometers and imagers: MEMS based Fabry-Perot Interferometers @ VTT

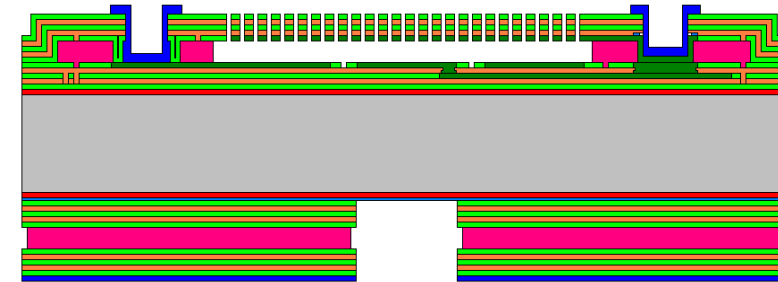
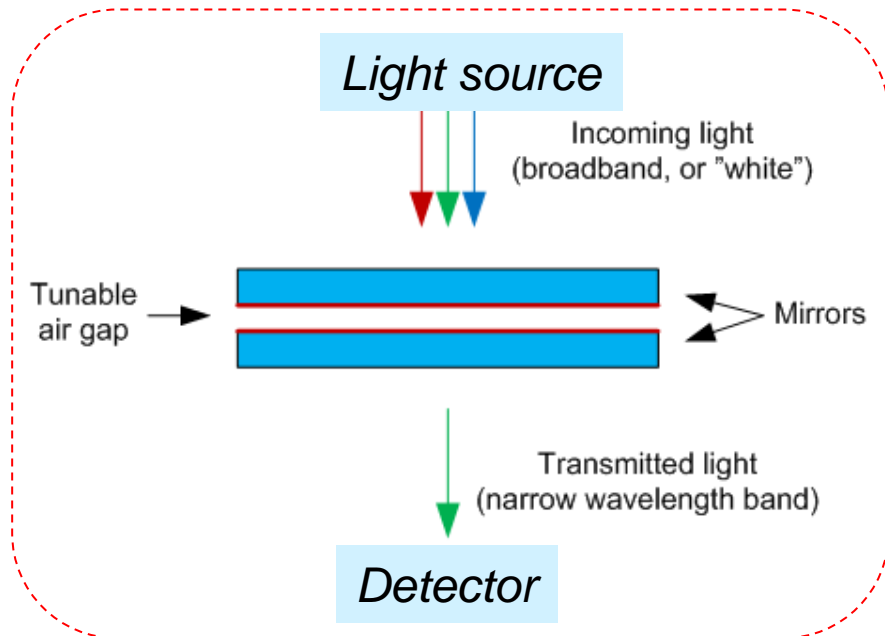

Packaged spectrometer

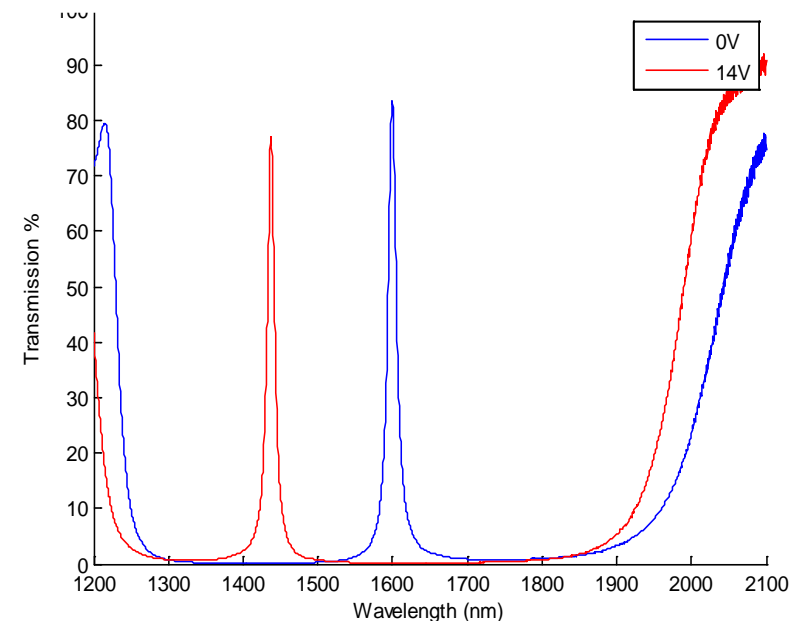

VTT's FPI technology in current applications

- Simple optical structure enables instrument customization for a variety of applications



Miniaturized
Thermal-IR
spectral
imagers

Unmanned aerial
vehicles (UAV) for
environmental
sensing and
precision
agriculture

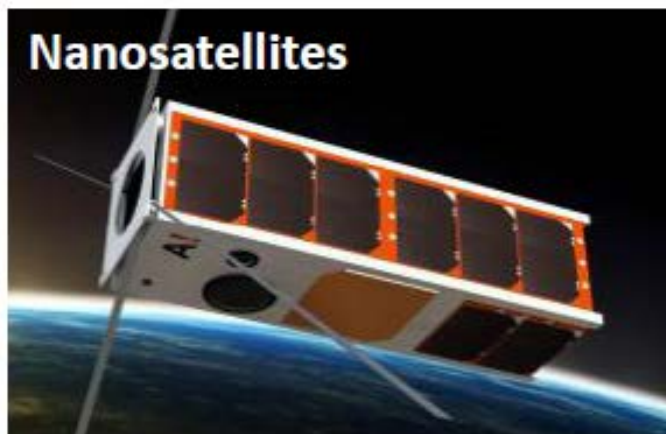

Nanosatellites



Industrial gas sensing;
simultaneous detection
of CO and CO₂ (MIR)



Skin cancer detection



Trace sensing (UV)

Detection of skin cancer

- VTT's hyper spectral camera can detect skin cancer within seconds
- Easy-to-use hand held instrument
- Fast screening and early detection of skin cancer

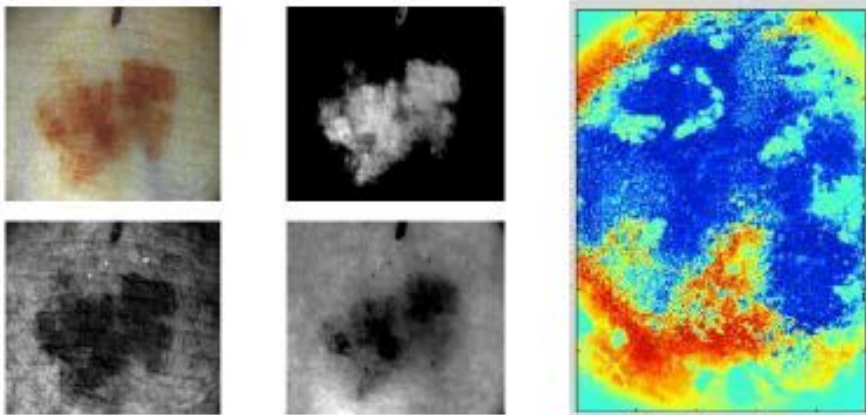

Hyperspectral imaging of cancerous tissue



Application being studied at the University of Jyväskylä, Päijät-Häme Central Hospital and Helsinki University Central Hospital

Application potential for spectral imaging

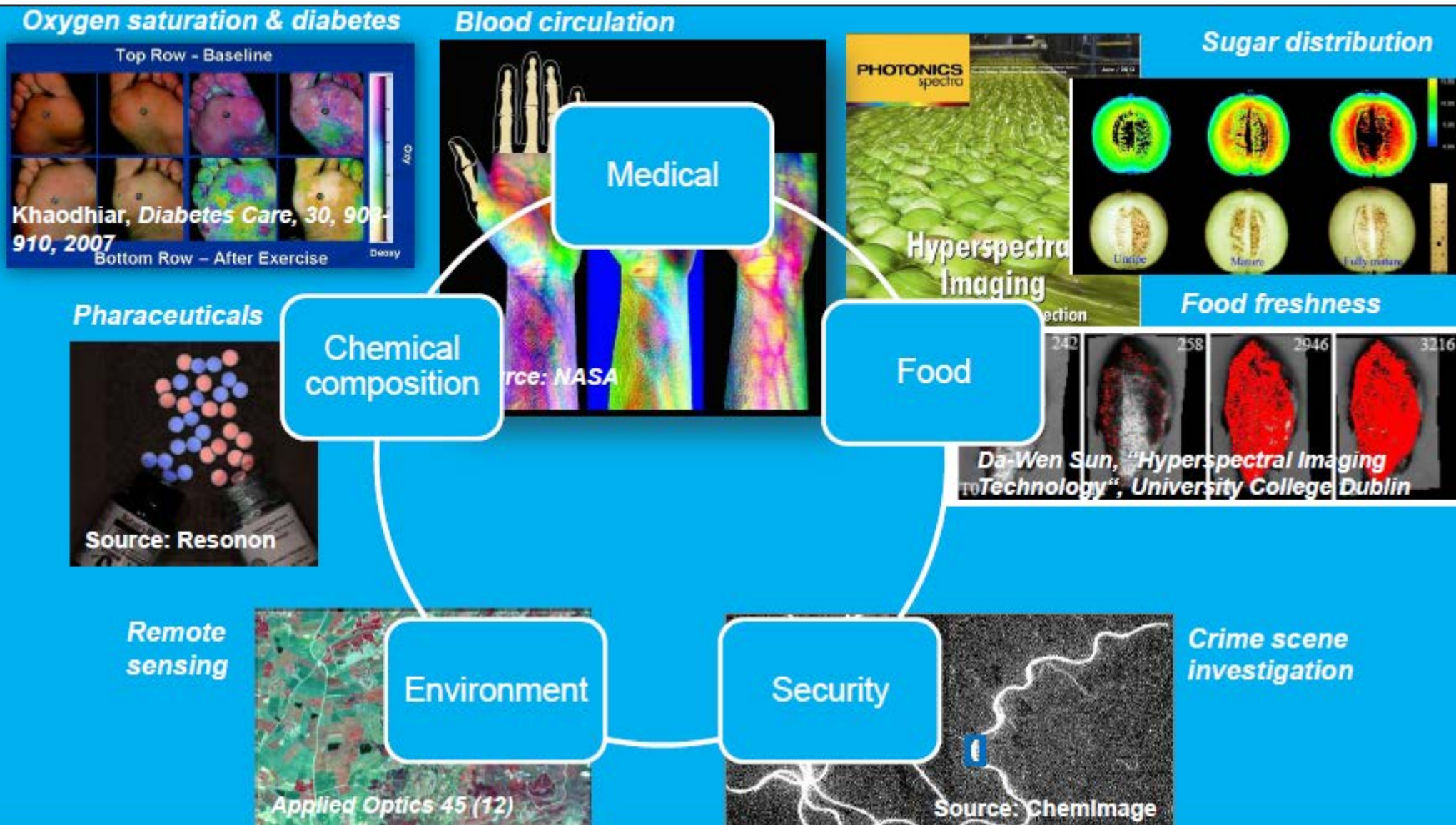

Silicon MEMS resonators with Quartz-class temperature stability

Optimized doping of silicon resonators dramatically enhances their temperature stability:

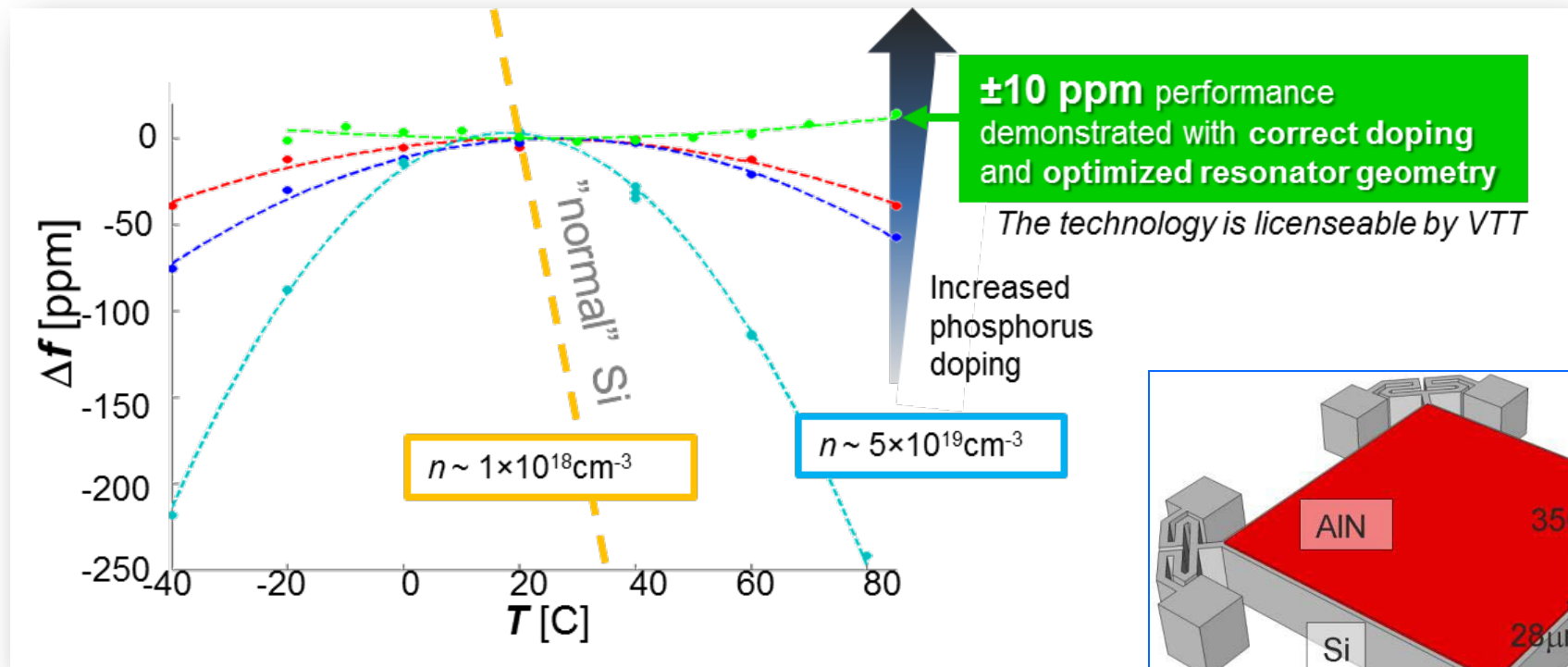

Conclusion



MEMS has a big yet-unexploited potential for new devices & solutions & services for health and environmental monitoring



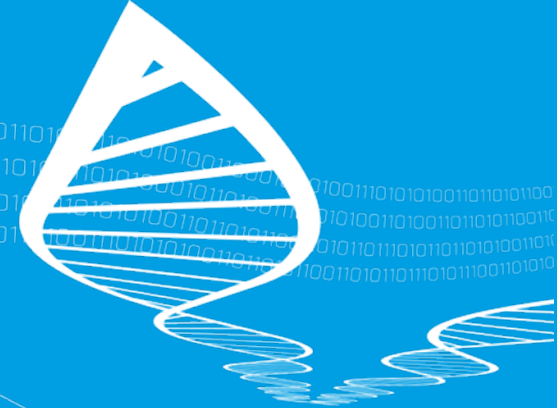

TECHNOLOGY «FOR BUSINESS»

